User's Manual

For

ACS606

Digital AC Servo Drive

Revision 1.0

©2009 All Rights Reserved

Attention: Please read this manual carefully before using the drive!



Leadshine Technology Co., Ltd.

3/F, Block 2, Nanyou Tianan Industrial Park, Nanshan Dist, Shenzhen, China

Tel: (86)755-26434369 Fax: (86)755-26402718

URL: www.leadshine.com E-Mail: sales@leadshine.com

The content in this manual has been carefully prepared and is believed to be accurate, but no responsibility is assumed for inaccuracies.

Leadshine reserves the right to make changes without further notice to any products herein to improve reliability, function or design. Leadshine does not assume any liability arising out of the application or use of any product or circuit described herein; neither does it convey any license under its patent rights of others.

Leadshine's general policy does not recommend the use of its products in life support or aircraft applications wherein a failure or malfunction of the product may directly threaten life or injury. According to Leadshine's terms and conditions of sales, the user of Leadshine's products in life support or aircraft applications assumes all risks of such use and indemnifies Leadshine against all damages.

©2009 by Leadshine Technology Company Limited.

All Rights Reserved

Table of Contents

1. Introduction, Features and Applications 1
 Introduction 1
 Features 1
 Applications 2
 2. Specifications and Operating Environment 2
 Electrical Specifications 2
 Performance Specifications 2
 Mechanical Specifications 3
 Elimination of Heat 3
 Operating Environment and Parameters 3
 3. Connections 4
 Connector Configuration 4
 General Information 4
 More about I/O Signals 5
 Control Signal Connections 6
 Encoder and Hall Sensor Connections 7
 RS232 Interface Connection 8
 Typical Connections 8
 4. Servo Setup 9
 Install Encoder and Hall sensor 10
 Prepare Power Supply 10
 Regulated or Unregulated Power Supply 10
 Selecting Supply Voltage 11
 Prepare Controller 11
 System Connections and Noise Prevention 11
 Wire Gauge 11
 Cable Routing 12

Twisted Wires 12
 Cable Shielding 12
 System Grounding 12
 Power Supply Connection 13
 5. Tuning the Servo 13
 Testing the Servo 13
 Tuning the Servo 14
 6. PC window based Tuning Using ProTuner 16
 Introduction to ProTuner 16
 Before Tuning 16
 ProTuner Installation 16
 Hardware Configurations before Tuning 20
 ProTuner for ACS606 at Startup Window 21
 Introduction to ProTuner for the ACS606 22
 Communication Setup 23
 Software Configuration before Tuning 24
 Current Loop Tuning 24
 Position Loop Tuning 28
 Position Loop Introduction 28
 Position around Velocity 28
 Position around Torque 28
 Start to Tune 29
 Upload and Download Data 39
 Download Data to EEPROM 39
 Upload the Data from EEPROM 39
 Save Data on Harddisk 40
 Download Data to Device 40
 Control Signal Input Mode 42
 More Informaiton about ProTuner 42
 T_Speed_Par tab 42

CurveSetting tab.....	43
Digital Scope Window.....	44
Error Check Window.....	44
7. Using Tips	46
Change PPR by Electronic Gear.....	46
Position following Error Limit	47
Sequence Chart of Control Signals.....	47
Protection Functions	48
Over-current Protection.....	48
Over-voltage Protection	48
Phase Error Protection.....	48
Encoder or Hall Error Protection.....	48
Position Following Error Protection.....	48
Protection Indications	49
Maximum Pulse Input Frequency	49
8. Accessories	50
ACS606 Accessories and Connections.....	50
More Information about ACS606 Accessories	51
APPENDIX	55
TWELVE MONTH LIMITED WARRANTY	55
EXCLUSIONS	55
OBTAINING WARRANTY SERVICE	55
WARRANTY LIMITATIONS.....	55
SHIPPING FAILED PRODUCT.....	56
Contact Us.....	57

1. Introduction, Features and Applications

Introduction

Leadshine's fully digital AC servo drive ACS606 is developed with 32-bit DSP based on advanced control algorithm. Since its input commands are PUL/DIR signals, the users can upgrade stepping drives to the ACS606 without changing control systems. The ACS606 can offer high precision, high speed and high reliability performance, and widely used in inkjet printers, engraving machines, and etc. A built-in controller can be used for testing and tuning. PC based and handheld configuration & tuning tools can meet different tuning environments or requirements. The ACS606 can drive both DC brushless and AC servo motors. But it is more suitable for the DC brushless servo motors. Compare to ACS806, ACS606 has less I/O thus has smaller size and higher cost-effective

Features

- I Input: 18 - 60VDC,
- I Peak Current: 15A , Continuous Current: 6 A (Max), 10 - 200 W
- I FOC-SVPWM technologies
- I PC based and handheld configuration tools
- I Electronic gear rate from 1/255 to 255
- I Self-test function with trapezoidal velocity profile
- I Support PUL/DIR and CW/CCW control signals
- I Opto-isolated, support single-ended and differential inputs
- I Following error lock range adjustable
- I Over-voltage, over-current, encoder failure protections
- I 10 latest failures self-record function
- I Small size, surface-mount technology

Applications

Suitable for large and medium automation machines and equipments, such as inkjet printers, engraving machines, electronic manufacturing equipments, special NC machines, pick and place devices, packing devices, and so on. Particularly adapt to the applications require high speed, high precision, and low motor noise.

2. Specifications and Operating Environment

Electrical Specifications ($T_j = 25^{\circ}\text{C}/77^{\circ}\text{F}$)

Parameters	ACS606			
	Min.	Typical	Max.	Unit
Peak output current	0	-	15	A
Continue output current	0	-	6	A
Supply voltage	+18	-	+60	VDC
Logic signal current	7	10	16	mA
Pulse input frequency	0	-	200	kHz
Isolation resistance	500			MΩ
Current provided to encoder	-	-	100	mA

Performance Specifications (with BLM Series Motors)

- l Position following error : +/-1 count
- l Velocity accuracy: +/-2rpm
- l Maximum acceleration speed (No Load) : 80 rpm/ms²
- l Maximum speed : 3000 rpm
- l Allowable low speed reaches 1 rpm
- l Positioning accuracy : +/-1 count
- l Suitable for 18 - 60 VDC AC/DC servo motors

Mechanical Specifications (unit: mm[inch])

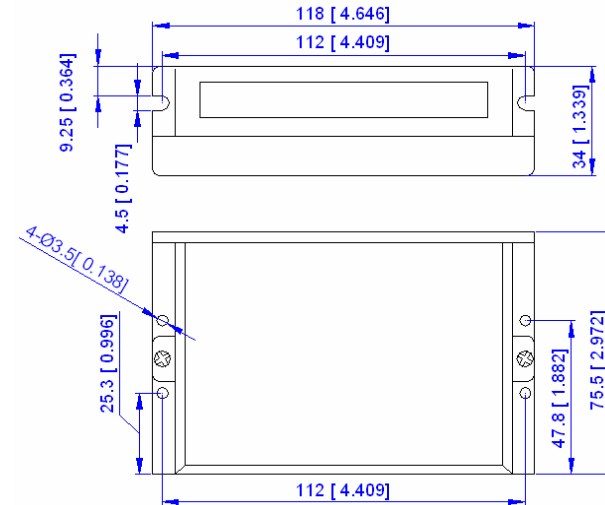

Figure 1: Mechanical specifications

Elimination of Heat

- l Drive's reliable working temperature should be $<70^{\circ}\text{C}$ [158°F], and motor working temperature should be $<80^{\circ}\text{C}$ [176°F].
- l It is recommended to mount the drive vertically to maximize heat sink area.

Operating Environment and Parameters

Cooling	Natural cooling or Forced cooling	
	Operating Environment	Environment
	Ambient Temperature	$0^{\circ}\text{C} - 50^{\circ}\text{C}$ ($32^{\circ}\text{F} - 122^{\circ}\text{F}$)
	Humidity	40% RH - 90% RH
	Vibration	5.9m/s^2 Max
Storage Temperature	$-20^{\circ}\text{C} - 65^{\circ}\text{C}$ ($-4^{\circ}\text{F} - 149^{\circ}\text{F}$)	
Weight	Approx. 280g (9.87oz)	

3. Connections

Connector Configuration

General Information

Feedback Signal Connector			
Pin	Signal	Description	I/O
1	EA+	Encoder channel A+ input	I
2	EB+	Encoder channel B+ input	I
3	EGD	Signal ground	GND
4	HW	Hall sensor W input	I
5	HU	Hall sensor U input	I
6	FG	Ground terminal for shielded	GND
7	EZ+	Reserve	I
8	EZ-	Reserve	I
9	HV	Hall sensor V input	I
10	NC	Not Connected	-
11	EA-	Encoder channel A- input	I
12	EB-	Encoder channel B- input	I
13	VCC	+5V @ 100 mA max.	O
14	NC	Not Connected	-
15	NC	Not Connected	-
Control Signal Connector			
Pin	Signal	Description	I/O
1	PUL+	Pulse signal input +	I
2	PUL-	Pulse signal input -	I
3	DIR+	Direction signal input +	I
4	DIR-	Direction signal input -	I
5	ENA+	Enable signal input +	I
6	ENA-	Enable signal input -	I

RS232 Communication Connector			
Pin	Signal	Description	I/O
1	NC	Not connected	-
2	+5V	+5V power only for STU.	O
3	TxD	RS232 transmit.	O
4	GND	Ground.	GND
5	RxD	RS232 receive.	I
6	NC	Not connected	-
High Voltage Connector			
Pin	Signal	Description	I/O
1	U	Motor phase U	O
2	V	Motor phase V	O
3	W	Motor phase W	O
4	+Vdc	DC power Input (18-60VDC)	I
5	GND	Power Ground.	GND

More about I/O Signals

Signal	Description
PUL+/PUL-	Pulse input signal. In single pulse (pulse/direction) mode, this input represents pulse signal, each rising or falling edge active (software configurable); 4-5V when PUL-HIGH, 0-0.5V when PUL-LOW. In double pulse mode (pulse/pulse), this input represents clockwise (CW) pulse, active at both high level and low level. For reliable response, pulse width should be longer than 0.85μs. Series connect resistors for current-limiting when +12V or +24V used. The same as DIR and ENA signals.
DIR+/DIR-	Directions input signal. In single-pulse mode, this signal has low/high voltage levels, representing two directions of motor rotation; in double-pulse mode (software configurable), this signal is counter-clock (CCW) pulse, active at both high level and low level. For reliable motion response, DIR signal should be ahead of PUL signal by 5μs at least. 4-5V when DIR-HIGH, 0-0.5V when DIR-LOW.
ENA+/ENA-	Enable input signal. This signal used for enabling/disabling the drive. High level for enabling the drive and low level for disabling the drive. Usually left UNCONNECTED (ENABLED) .

Control Signal Connections

The ACS606 has 3 differential logic inputs to accept Enable, Pulse and Direction control signals. These inputs are isolated to minimize or eliminate electrical noises coupled onto the control signals. Recommend use twisted wires and shielding cable for control signals to increase noise immunity in interference environments. Keep these wires far away from the power lines. In figure 2, input circuit for these control signals and connections to a typical motion controller is illustrated. Figure 3 illustrates connections to the controller with common-anode outputs.

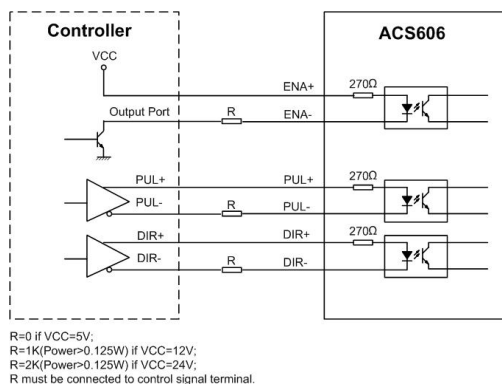

Figure 2: Connections to controller with differential outputs

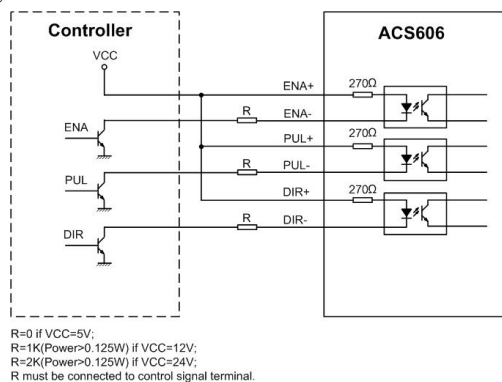

Figure 3: connections to controller with Common-Anode outputs

Encoder and Hall Sensor Connections

The ACS606 can accept both incremental encoder and hall effect sensor inputs for motor shaft position feedbacks. Note that twisted-pair shielded cabling provides the best immunity in electrically noisy environments.

The ACS606 has the +5V power to supply the encoder & hall sensor. If the encoder and hall sensor drains less than 100mA, the ACS606 can supply them directly, and connect it as Figure 7. If the encoder drains more than 50mA, use an external DC supply and connect it as Figure 8.

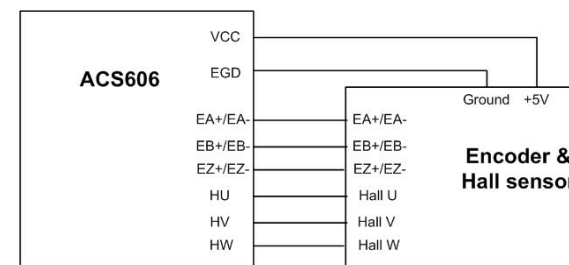

Figure 7: The ACS606 supplies the encoder directly

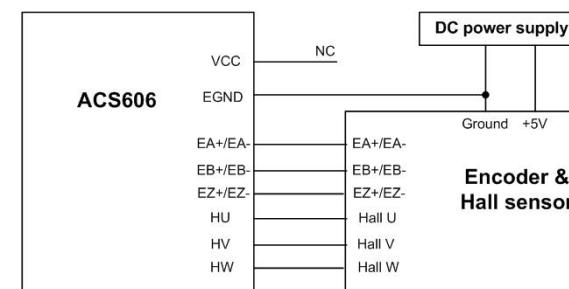

Figure 8: Using external DC power supply to supply the encoder

RS232 Interface Connection

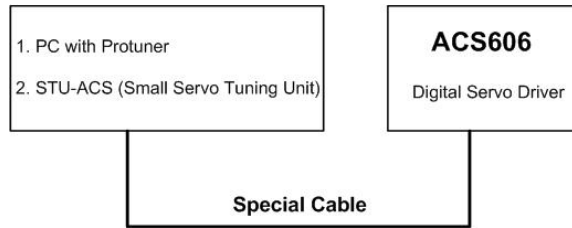

Figure 9: RS232 interface connection

Typical Connections

A typical connection of the ACS606 is shown as Figure 10. Please consult “Control Signal Connections” and “Encoder and Hall Sensor Connections” for more information about controller and encoder connections.

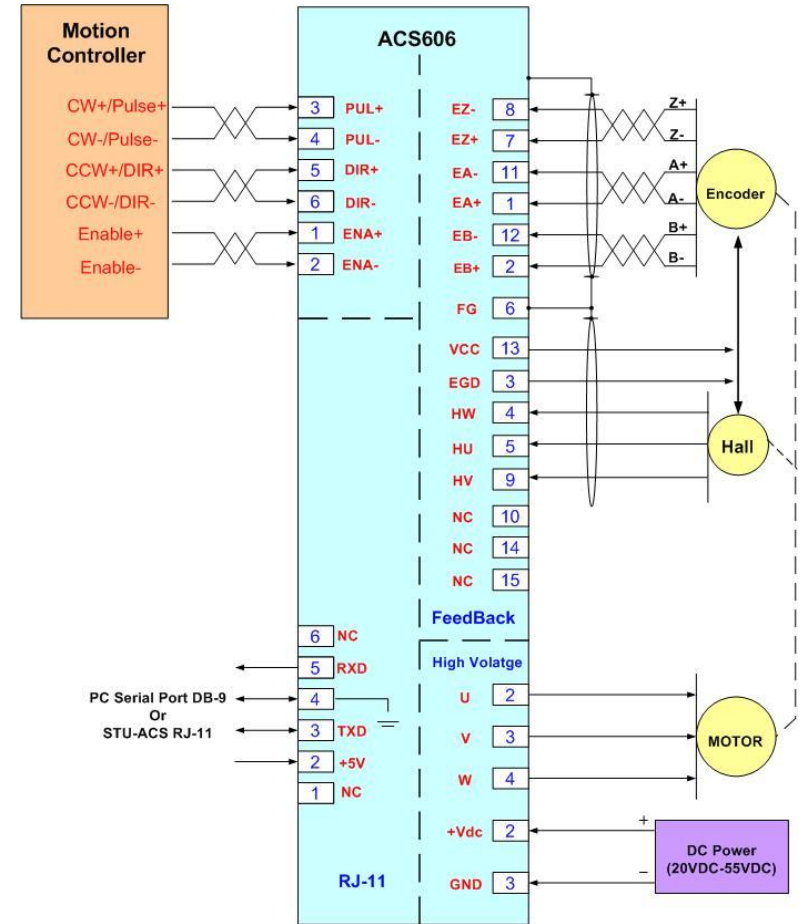

Figure 10: Typical connection of the ACS606

4. Servo Setup

Before you start the servo, you can follow the below steps.

Install Encoder and Hall sensor

Encoder and Hall sensor provide information of the motor shaft position and rotor magnetic field orientation. The output signals from the Hall sensor have absolute phase information which is used at motor startup. If your motor has no encoder and hall sensor, you must have an encoder (more than 200 lines) and hall sensor properly mounted on the motor before you start.

There are some modules which can output signals both for encoder and hall sensor. Please assemble the selected module according to its factory manual. Leadshine also offer BLM series DC brushless servo motors for matching the ACS606. Please use shielded cables and separate encoder signal cable from interference sources, such as motor wires and power wires at least 5 cm.

Prepare Power Supply

Regulated or Unregulated Power Supply

Both regulated and unregulated power supplies can be used to supply the Drive. However, unregulated power supplies are preferred due to their ability to withstand current surge. If regulated power supplies (such as most switching supplies.) are indeed used, it is important to have large current output rating to avoid problems like current clamp, for example using 4A supply for 3A motor-drive operation. On the other hand, if unregulated supply is used, one may use a power supply of lower current rating than that of motor (typically 50%~70% of motor current). The reason is that the Drive draws current from the power supply capacitor of the unregulated supply only during the ON duration of the PWM cycle, but not during the OFF duration. Therefore, the average current withdrawn from power supply is considerably less than motor current. For example, two 3A motors can be well supplied by one power supply of 4A rating.

Selecting Supply Voltage

The ACS606 can actually operate within +18 ~ +60VDC, including power input fluctuation and back EMF voltage generated by motor coils during motor shaft deceleration. The rated voltage of the motor is an important parameter when selecting supply voltage. Generally speaking, do not use a power supply voltage more than 5 volts of the rated voltage of the motor. Higher voltage may cause bigger motor vibration at lower speed, and it may also cause over-voltage protection or even drive damage.

Prepare Controller

Prepare a controller with pulse and direction signals. However, the ACS606 has a built-in motion controller for self-test and Servo Tuning. The built-in motion controller can generate control signal with trapezoidal velocity profile.

System Connections and Noise Prevention

After finishing the above steps, you can connect your servo system. Before you start, make sure that the power is off. Connect your system according to previous connection diagrams, and pay attention to the following tips when wiring.

Wire Gauge

The smaller wire diameter (lower gauge), the higher impedance. Higher impedance wire will broadcast more noise than lower impedance wire. Therefore, when selecting the wire gauge, it is preferable to select lower gauge (i.e. larger diameter) wire. This recommendation becomes more critical as the cable length increases. Use the following table to select the appropriate wire size to use in your application.

Current (A)	Minimum wire size (AWG)
10	#20
15	#18
20	#16

Cable Routing

All content sensitive signal wires should be routed as far away from motor power wires and Drive power wires as possible. Motor power and Drive power wires are major sources of noise and can easily corrupt a nearby signal. This issue becomes increasingly important with longer motor power and Drive power wires lengths.

Twisted Wires

Twisted wires effectively increase noise immunity. The successive twists eliminate noise transients along the length of the cable. Both signal cables and power cables should be of the twisted and shielded type. Differential signal wires should be twisted as a pair. The combination of twisted pair wires and a differential signal significantly adds to noise immunity. Power wires should be twisted as a group along with the ground (or chassis) wire, if available.

Cable Shielding

All signal wires should be bundled and shielded separately from Drive power and motor power wires. Power wires should also be bundled and shielded. When grounding a shield, the rule-of-thumb is to do so at the ‘source’ of power while leaving the other shield end open. For example, in the case of motor power wires, this would be the drive side. Ideally, twisted pairs should be individually shielded and isolated from the outer shield, which encompasses all wires within the cable. However, since this type of stringent shielding practice is often not required, typical cables do not provide isolation between inner and outer shields.

System Grounding

Good grounding practices help reduce the majority of noise present in a system. All common grounds within an isolated system should be tied to PE (protective earth) through a ‘SINGLE’ low resistance point. Avoiding repetitive links to PE creating ground loops, which is a frequent source of noise. Central point grounding should also

be applied to cable shielding; shields should be open on one end and grounded on the other. Close attention should also be given to chassis wires. For example, motors are typically supplied with a chassis wire. If this chassis wire is connected to PE, but the motor chassis itself is attached to the machine frame, which is also connected to PE, a ground loop will be created. Wires used for grounding should be of a heavy gauge and as short as possible. Unused wiring should also be grounded when safe to do so since wires left floating can act as large antennas, which contribute to EMI.

Power Supply Connection

NEVER connect power and ground in the wrong direction, because it will damage the ACS606 drive. The distance between the DC power supply of the drive and the drive itself should be as short as possible since the cable between the two is a source of noise. When the power supply lines are longer than 50 cm, a 1000 μ F/100V electrolytic capacitor should be connected between the terminal “GND” and the terminal “+VDC”. This capacitor stabilizes the voltage supplied to the drive as well as filters noise on the power supply line. Please note that the polarity can not be reversed.

It is recommended to have multiple drives to share one power supply to reduce cost if the supply has enough capacity. To avoid cross interference, **DO NOT** daisy-chain the power supply input pins of the drives. Instead, please connect them to power supply separately.

5. Tuning the Servo

Testing the Servo

You may wish to secure the motor so it can’t jump off the bench. Turn on the power supply, the green (Power) LED will light. The ACS606 has default parameters stored in the drive. If the system has no hardware and wirings problem, the motor should be locked and the drive should be ready.

If the motor jumps slightly and the red LED immediately turns on (flickers), then either the motor or the encoder is wired in reversal. Open the tuning software ProTuner and check drive status by clicking **Err_check**. If it's **Phase Error**, then exchange motor wires or encoder inputs and try again. If it's **Encoder Error**, please check encoder and its wirings, and then try again. If it still doesn't work after you followed all of the previous steps, please contact us at tech@leadshine.com.

If the red LED is off and the motor is normal, then you can start to tune the servo with selected tool. PC based tuning software **ProTuner** and handheld small servo tuning unit **STU** are available for the ACS606.

Tuning the Servo

A servo system is error-driven. The “Gain” of the system determines how hard the servo tries to reduce the error. A high-gain system can produce large correcting torques when the error is very small. A high gain is required if the output is required to follow the input faithfully with minimal error.

A servo motor and its load both have inertia, which the servo amplifier must accelerate and decelerate while attempting to follow a change at the input. The presence of the inertia will tend to result in over-correction, with the system oscillating beyond either side of its target. It's called UNDER DAMPED status. See Figure 11. This oscillation must be damped, but too much damping will cause the response to be sluggish, namely cause the system to get into an OVER DAMPED state. When we tune a servo, we are trying to achieve the fastest response with little or no overshoot, namely get a CRITICALLY DAMPED response.

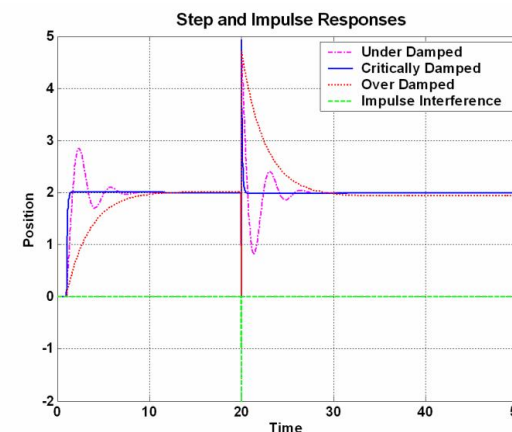

Figure 11: Step and impulse responses

As mentioned in previous contents, the ACS606 is a digital servo drive and its input command is PUL/DIR signal. In other words, step response just exists in each step command signal. For each step command signal is a very small movement, so OVER SHOOT and SETTLING TIME between each step are very small, causing you hardly can see a step response such as Figure 11, even if the SET POINT is a very large quantity and the acceleration is very high.

However, if you try to evaluate performances of the digital servo by investigating its position tracking-error or position following error, you may find it's much easier than investigating its step response. The easiest way to get a tracking-error or position following error response is to induce an impulse load on the motor. See Figure 11 at “time 20”.

Leadshine offers a Windows based setup software **ProTuner** to its customers for evaluating servo performances. Small servo tuning unit **STU** (optional) is available too, and it's for field tuning without PC.

Tuning servo systems formed by the ACS606 can be summarized as the following rules:

1. If servo system is UNSTABLE, then the first thing of tuning is to stabilize the system. You can increase **Derivative Gain** of **Position Loop** (Kd) or decrease **Proportional Gain** of Position Loop (Kp) or **Integral Gain** of Position Loop (Ki).
2. If servo system is UNDER DAMPED, then increase Kd or decrease Kp or Ki.
3. If servo system is CRITICALLY DAMPED, then stop tuning and download the parameter settings to the Drive's EEPROM.
4. If servo system is OVER DAMPED, then decrease Kd or increase Kp or Ki.

6. PC window based Tuning Using ProTuner

Introduction to ProTuner

As a professional tuning tool, ProTuner has been developed specially for all Leadshine digital drives. It can be also used to configure the servo drive for many settings such as control signal modes, number of motor poles, position following error limit, default move direction, and etc. The most important feature is ProTuner offers the numeric method for tuning position-loop parameters (Kp, Kd, Ki) and give a visualization result synchronously for users to evaluate the performance of the system.

Before Tuning

ProTuner Installation

The ProTuner is windows based setup software for tuning Leadshine's digital drives. It can run in windows systems, including Win95/Win98/WindowsNT/Windows2000/Windows XP. And the selected PC should have 1 serial port at least for communicating with the drive.

Double click "**ProTuner_All_Setup_V1.0.exe**" to begin installing the **ProTuner**. See

Figure 12. Click **Next** to enter the "License Agreement" window. See Figure 13.

Note: **ProTuner_All_Setup_V1.0.exe** can be used for all Leadshine digital drives. User can get it from either Leadshine CD or website. Please get the latest version from <http://www.leadshine.com>.



Figure 12: Begin to install the ProTuner

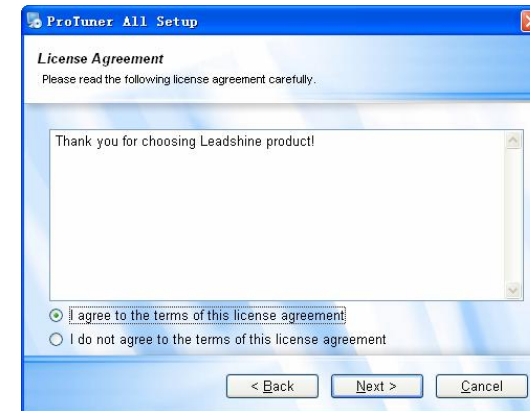

Figure 13: License agreement

Choose "I agree to the terms of this license agreement" and click **Next** to continue installation. The user can enter user's information in the following window. See

Figure 14. After entering the user's information, click **Next** to select installation folder, where you would like to install the **ProTuner**. See Figure 15.

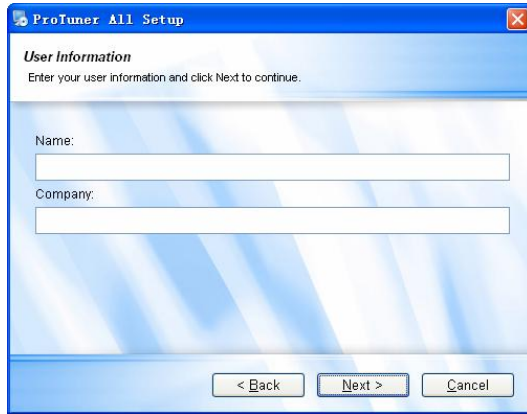

Figure 14: User's information settings

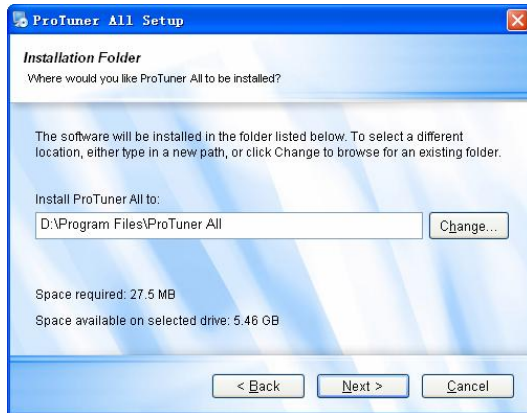

Figure 15: Installation folder settings

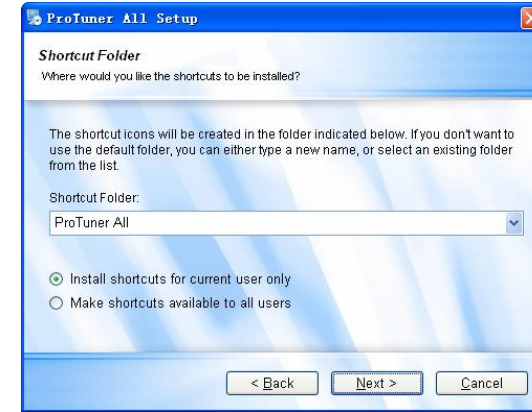

Figure 16: Shortcut folder setting

Set the "Shortcut Folder" in Figure 16 and continue to install the **ProTuner** by following Figure 17 and Figure 18. An **Installation Successful** window will appear if the **ProTuner** is installed successfully. See Figure 19.

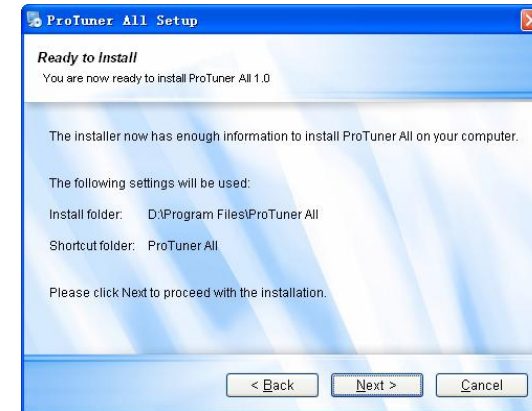

Figure 17: Installation information summarization

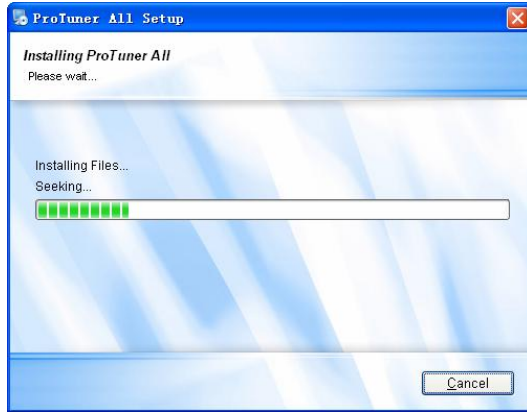

Figure 18: Installing the ProTuner

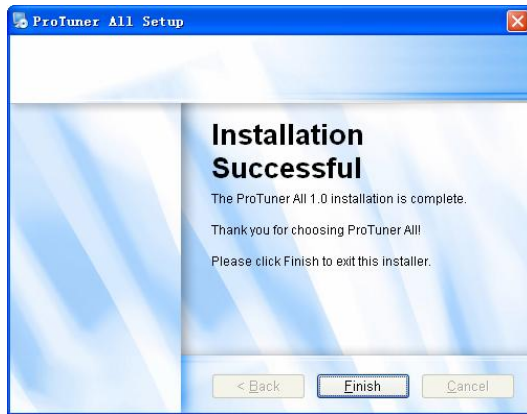

Figure 19: Finish installation

Note: Leadshine also offers special version ProTuner which does not need installation. Please visit our website www.leadshine.com for latest ProTuner.

Hardware Configurations before Tuning

ProTuner uses PC RS232 port to communicate with the ACS606. The ACS606 has a RJ-11 connector in which a special RS232 cable is connected to PC RS232 port. Before opening ProTuner to tune the ACS606, the following configuration must be

achieved as figure 20.

1. A power supply which has sufficient output current at related voltage;
2. DC brushless servo or AC servo motor (power range: 10 – 200W) with encoder and hall sensor feedback.
3. Desktop or laptop with one RS232 communication port at least or a USB to RS232 adapter. Recommend using Desktop with RS232 port.
4. A special RS232 cable offered by Leadshine in which one end is a RJ-11 connector and the other end is a DB9 connector.

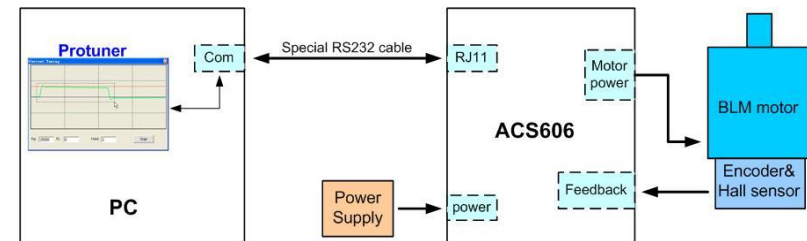

Figure 20: Configuration and connections before Tuning

Note:

1. If it is the first installation, strongly recommended that tune the ACS606 and servo motor without motor shaft coupling to any load. After basic values of the parameters are achieved, connect the motor to the load for further tuning. These basic parameters can also be used for other drives with the same servo motors.
2. Please double check the connections and make sure the motor would not jump off before powering on the drive if start at a high acceleration.
3. In order to setup communication between the drive and ProTuner, the ACS606 should be powered.

ProTuner for ACS606 at Startup Window

Power on the ACS606. The green LED indicator should be on and the motor shaft should be locked if the servo system is OK. Please refer to the **protection functions**

to check the errors if red LED indicator blinks.

Open **ProTuner** and the startup window appears as figure 21. For the ACS606, please select the **ACS606** in AC Servo tab then click OK button.

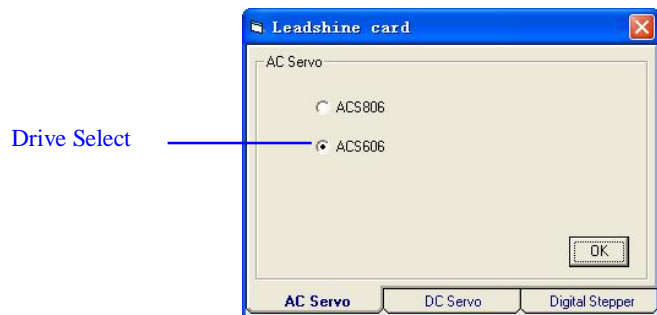

Figure 21: Startup Window of ProTuner

Introduction to ProTuner for the ACS606

1. Main Window

Many of the Leadshine products have similar user interfaces like figure 22.



Figure 22: Main window of ProTuner for the ACS606

2. Menu Bar and Submenu

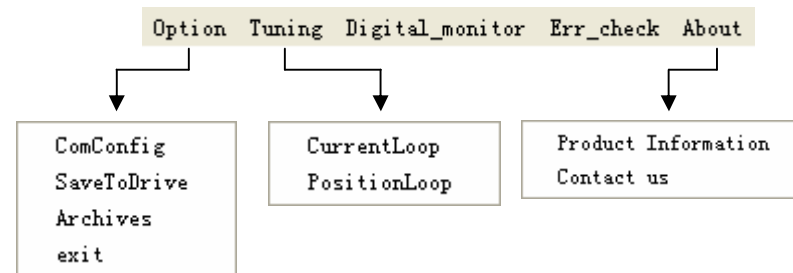

Figure 23: ProTuner menu for ACS606

Communication Setup

Select **Option->ComConfig**, a dialogue window for setting the RS232 communication parameters would appear as figure 24. Select a correct port according to the actual port used. Click the 'Open' button to establish communication between the ACS606 and ProTuner. The caption of the button should change to 'Close' if communication has been successfully established. Click this button again to release the communication.

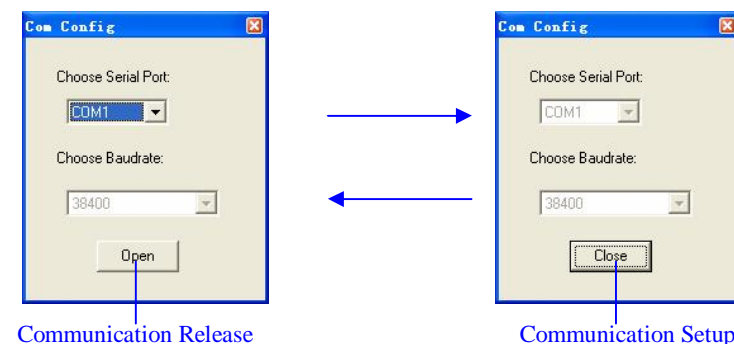

Figure 24: Establish and release serial communication

Software Configuration before Tuning

Some parameters must be configured before tuning the drive and the motor. Select **Tuning ->PositionLoop** to open the position-loop window. Set the parameters according to the description in figure 25.

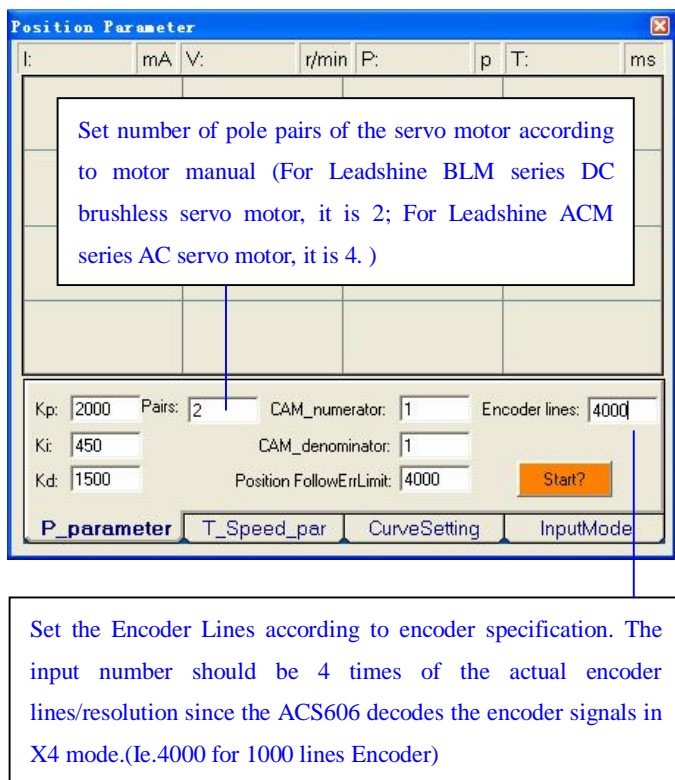

Figure 25: Software configuration before Tuning

Current Loop Tuning

For most of the ACS606 drives which are shipped with Leadshine’s BLM series servo motors, Leadshine will tune the current loop before sending them to customers. Current Loop tuning is a reserved function, and when opening the current tuning

window by selecting **Tuning->CurrentLoop**, a password input window will appear. **Leadshine just offers password to some customers for tuning current loop**, while most of customers just need to tune the position loop parameters if they use the drives with Leadshine’s BLM series servo motors. If you use the ACS606 with servo motors from other manufacturers, the current loop tuning may be needed. Please contact tech@leadshine.com for the password to tune the current loop.

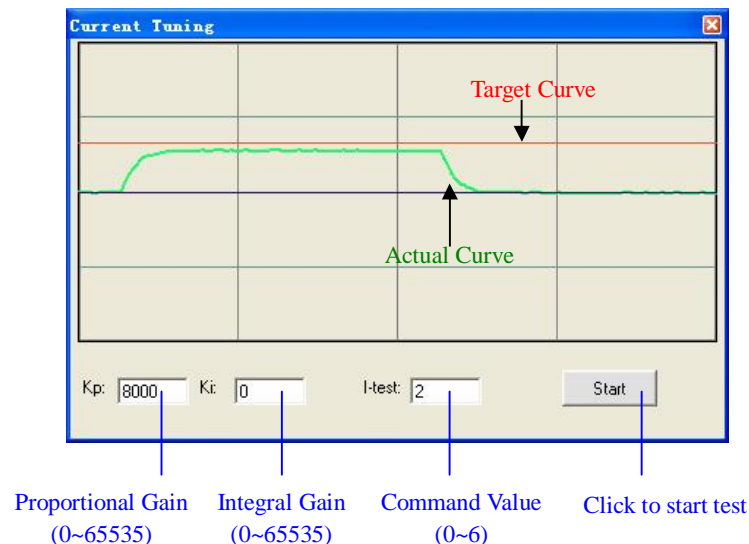

Figure 26 Current-loop tuning window (Kp=10000)

To start the current-loop tuning, please enter a target value in the I-test field (unit: A). Then take the following steps to get optimal step response.

1. Give Kp a value and set Ki 0. Click the ‘Start’ button and observe the green curve in the window.
2. If the response is an over-damped response as shown in figure 26, increase Kp until get an under-damped response as figure 27.
3. If get a large overshoot response as shown in figure 28, decrease Kp to get a smaller overshoot response as figure 27.

- After getting a small overshoot response, increase K_i to reduce the steady-state error until get a critically damped response. See figure 29.

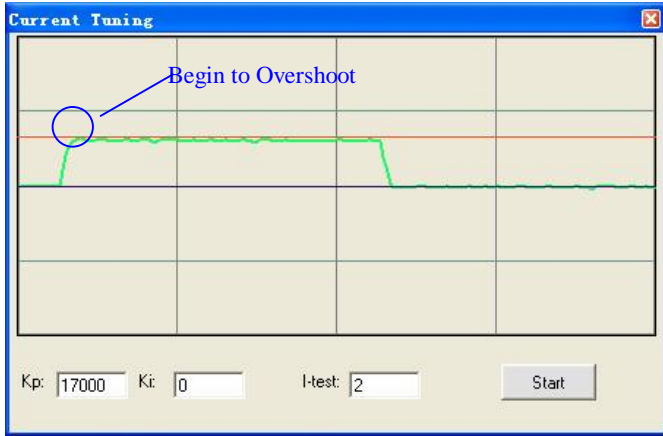

Figure 27: Step response with better K_p of current-loop ($K_p = 17000$)

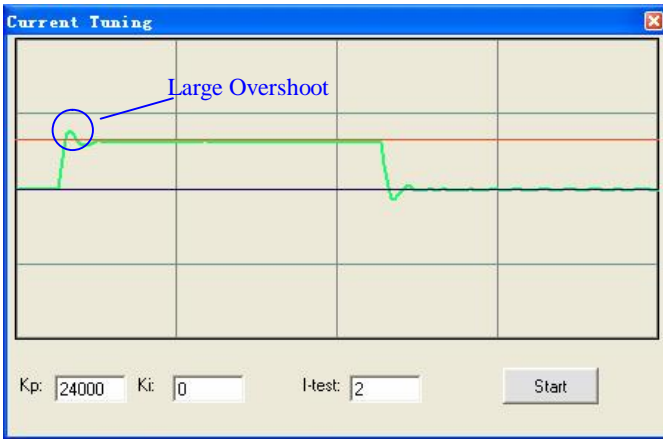

Figure 28: Response with High K_p of current-loop ($K_p = 24000$)

- At that moment K_p and K_i of the current loop is nearly optimum. To reduce the raise time please increase K_p , and increase K_i to reduce the steady-state error. You can use the mouse to drag a rectangle to zoom in the curve for more detail. Click any place of the window to zoom out. See figure 30.

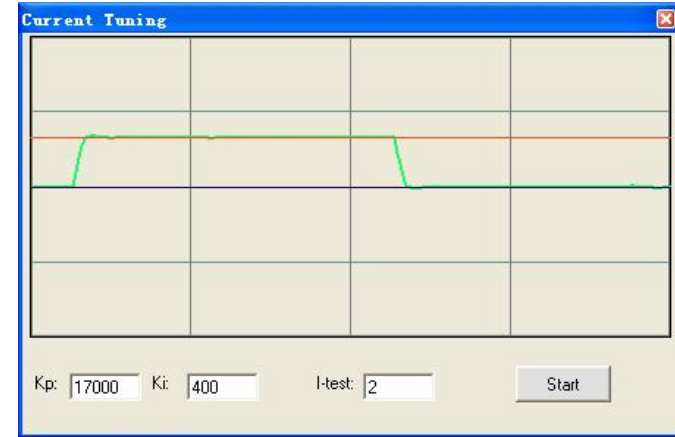

Figure 29: Step response with better K_p and K_i of current-loop ($K_p=17000, K_i=400$)



Figure 30: Drag a rectangle to zoom in

Position Loop Tuning

Position Loop Introduction

Position loop tuning is dependant on the mechanical load, and therefore will change with any mechanical system changes. Position loop tuning should be performed with the motor installed in the system. The position loop can be closed around velocity or torque mode (depending on whether the velocity loop is enabled or disabled). If it is closed around velocity mode, the position loop algorithm output becomes the new velocity set point. If it is closed around torque mode, the position loop algorithm output becomes the new torque set point. There are some important differences in the tuning process and application of these two approaches.

Position around Velocity: This mode is most common in "contouring" application, where a position trajectory must be tracked very closely. The velocity loop provides additional "stiffness", and keeps the dynamic position errors minimal, since the system now reacts to not just position errors, but also velocity errors (which can be interpreted as position error changes). It is important to start with a stable yet responsive velocity loop. Typically, it is sufficient to just use the position loop proportional gain. Feedforward gain can be added to improve tracking performance (i.e. minimize the difference between commanded and actual position). The velocity loop is disabled in current version ACS606, and it adopts **Position around Current** (Torque) mode.

Position around Torque: This mode is most common in point-to-point applications, where actual motion between start and end point is not very critical. In this case, velocity loop tuning can be avoided. This can be advantageous if the velocity feedback is poor (e.g. low resolution encoder, poor encoder quadrature.). **In this case, the tuning process requires that the position loop proportional and derivative gain are increased simultaneously, unless the system has sufficient friction, in which case no derivative gain is necessary. Once a stable response is achieved, integral gain can be added to improve stiffness.** It is best to use a step command

with the profiler enabled as a reference signal during tuning.

Drive tuning is a multi-step process that involves proper tuning of up to three different servo loops, namely current loop, velocity loop and position loop. You can either tune the position loop around the velocity loop, or around the current loop. Generally, it is much easier to tune a position loop around a velocity loop because only the proportional gain is needed. When tuning position around the current loop, a high derivative gain may be necessary on top of both proportional and integral gains.

Start to Tune

Set the parameters and select the curves displayed in **Digital Monitor** before starting self-test and tuning. See Figure 31 and Figure 32 for the parameters for the tuning in this paper. When we tune a servo, we are trying to achieve the fastest response with little or no overshoot, namely get a Critically Damped response.

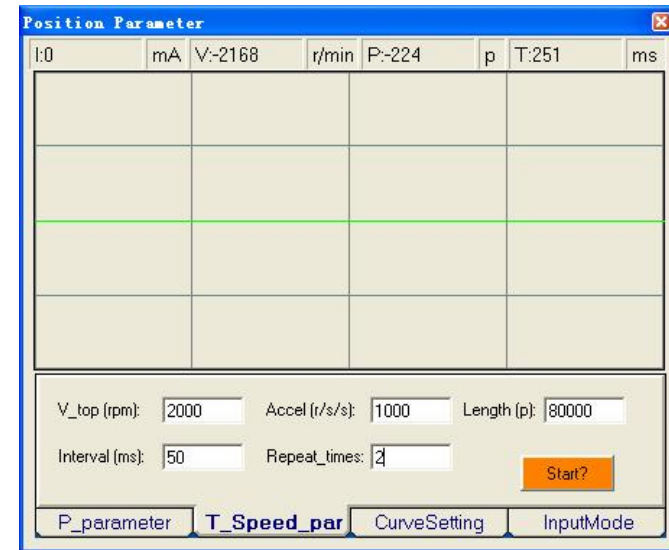

Figure 31: Self-test motion settings for the tuning

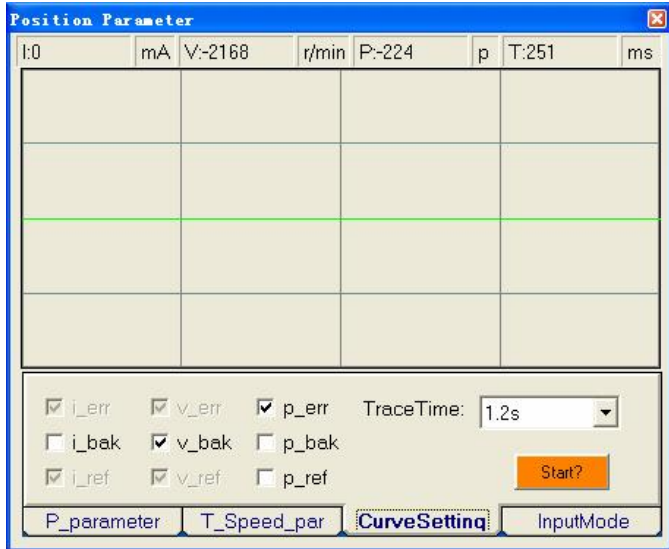

Figure 32: Digital Scope settings for the tuning

As mentioned above, the ACS606 adopts position around current (torque) mode, and when tuning position around the current loop, a high derivative gain may be necessary on top of both proportional and integral gains. Here, we set $K_p=2000$, $K_i=0$, $K_d=1000$ first, and the self-test result is shown in Figure 33.

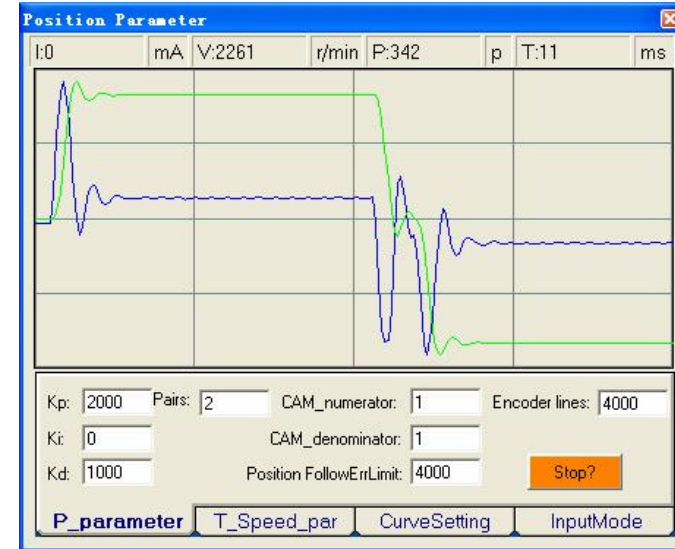

Figure 33: Position following error curve and velocity curve ($K_p=2000$, $K_i=0$ and $K_d=1000$)

It's very easy to see from the velocity curve (Green line) that the system is under damped. This will cause system oscillating beyond either side of its target, so it must be damped. Figure 26 shows the result after increasing K_d to 3500. In the Figure 34, the oscillation is much smaller than that of Figure 33. You can get even smaller oscillation when increasing K_d to 7000. See Figure 35.

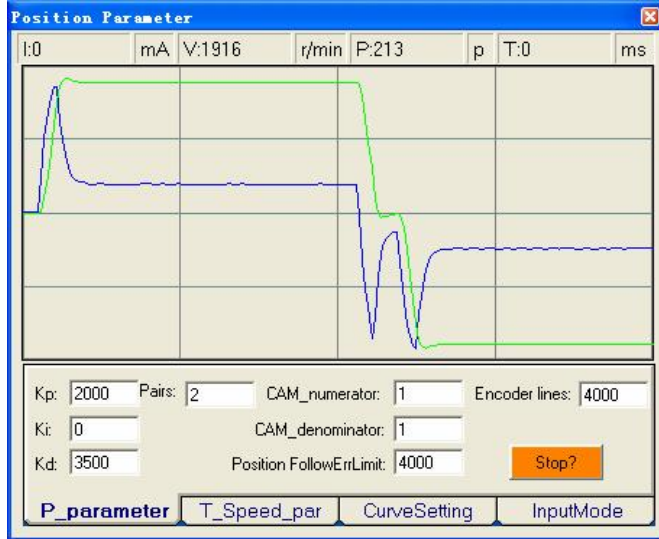

Figure 34: Position following error curve and velocity curve (Kp=2000, Ki=0 and Kd=3500)

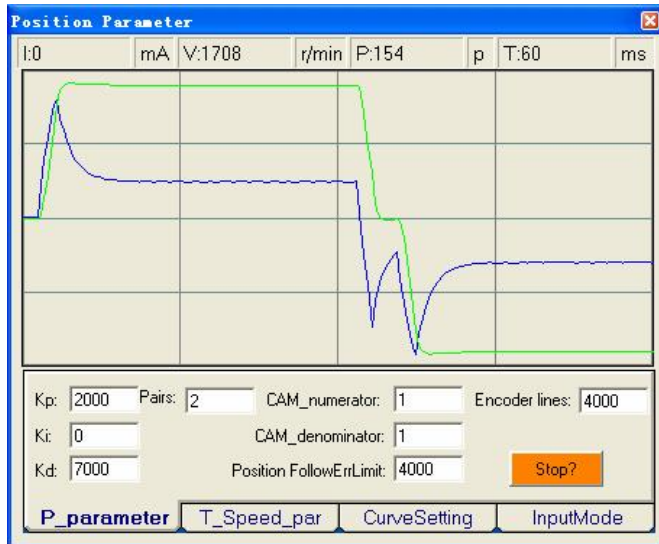

Figure 35: Position following error curve and velocity curve (Kp=2000, Ki=0 and Kd=7000)

Although a smooth velocity curve have been gotten in Figure 35, we can see that the position following error is still too large to accept. And this can be improved by increasing Ki value. See Figure 36. However, we can see the system response in Figure 35 is already Over Damped, namely too much damping has caused the response to be sluggish. This can be improved by increasing Kp or reducing Kd. See Figure 37 and Figure 38. Here we try to improve the performances by increasing Kp.

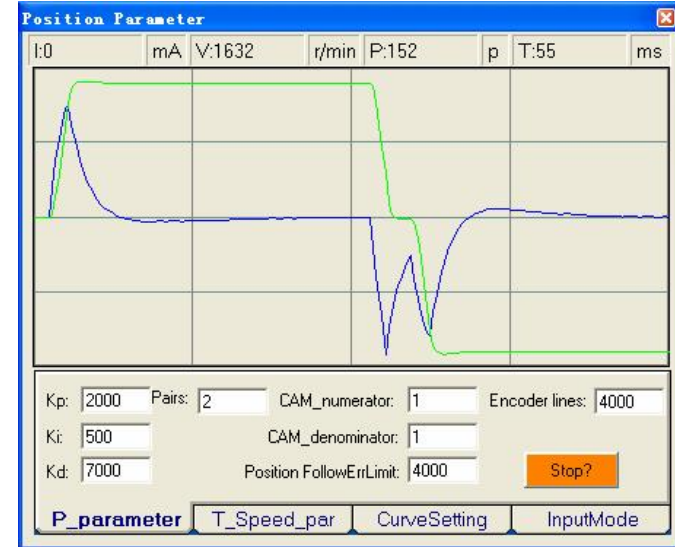

Figure 36: Position following error curve and velocity curve (Kp=2000, Ki=500 and Kd=7000)

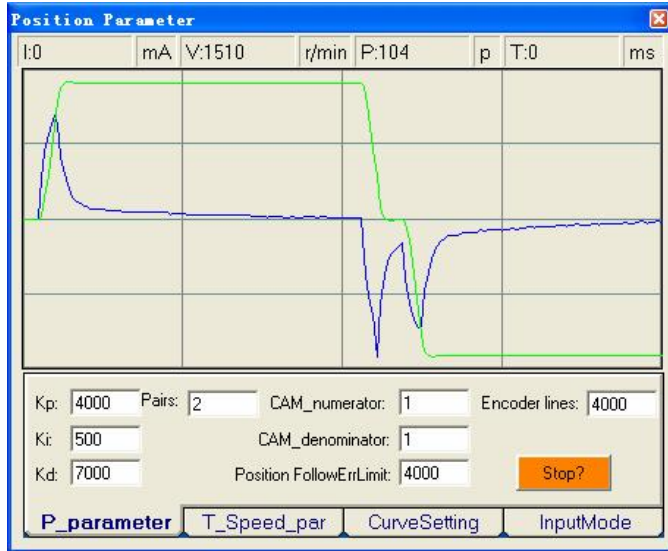

Figure 37: Position following error curve and velocity curve (Kp=4000, Ki=500 and Kd=7000)

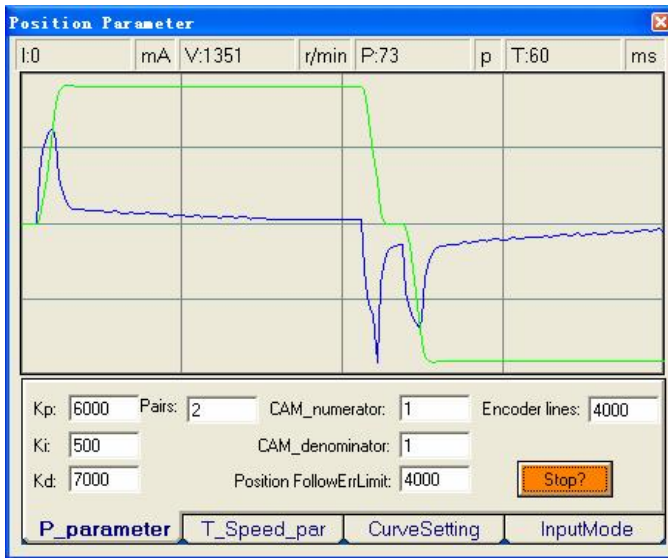

Figure 38: Position following error curve and velocity curve (Kp=6000, Ki=500 and Kd=7000)

Increase Kd can reduce velocity overshoot, and get a better velocity curve in as shown in Figure 39.

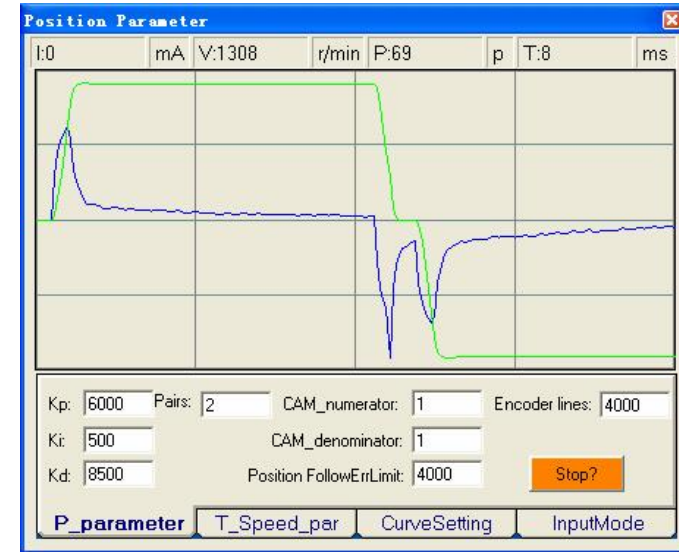

Figure 39: Position following error curve and velocity curve (Kp=6000, Ki=500 and Kd=8500)

Since position following error is still large during constant speed period in Figure 39, we try to increase Ki to improve system's performances. Figure 40, Figure 41, and Figure 42 show the result after increasing Ki. From Figure 42, we can see that too much Ki will cause position curve over shoot.

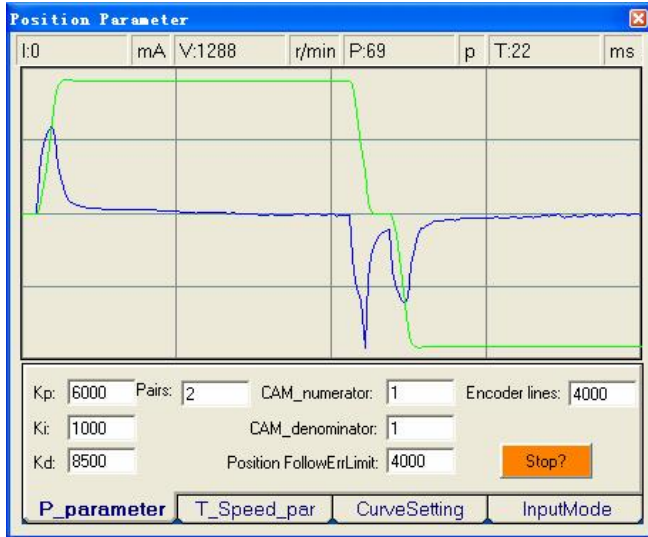

Figure 40: Position following error curve and velocity curve ($K_p=6000$, $K_i=1000$ and $K_d=8500$)

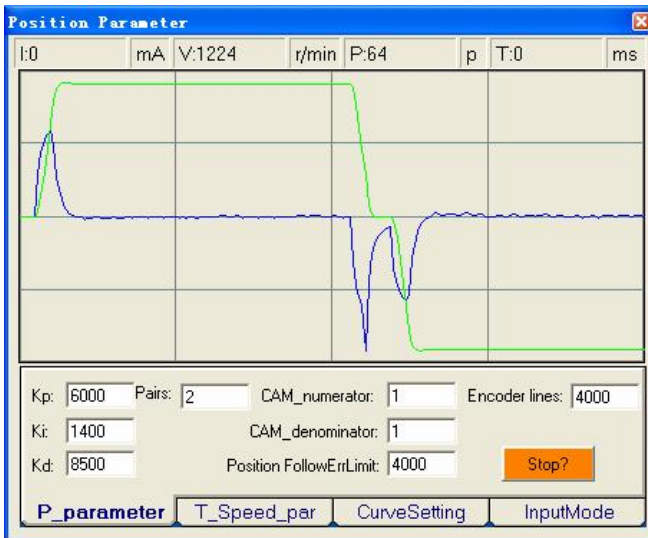

Figure 41: Position following error curve and velocity curve ($K_p=6000$, $K_i=1400$ and $K_d=8500$)

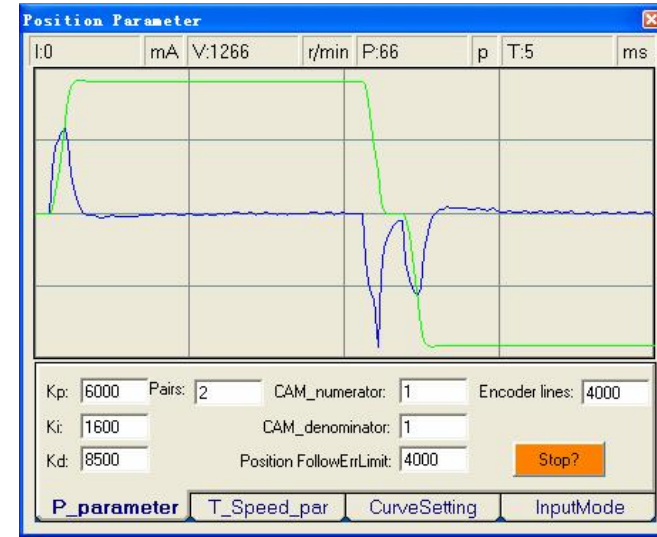

Figure 42: Position following error curve and velocity curve ($K_p=6000$, $K_i=1600$ and $K_d=8500$)

Increasing K_p a little and reducing K_i to 1400 can achieve a faster response with little overshoot, namely get a response close to Critically Damped response. See Figure 43. Remember to download the parameter settings to the drive's EEPROM when you get a satisfying performance. You can also save them to a config file on the PC harddisk then use these parameters for other drives. See detail in next chapter.

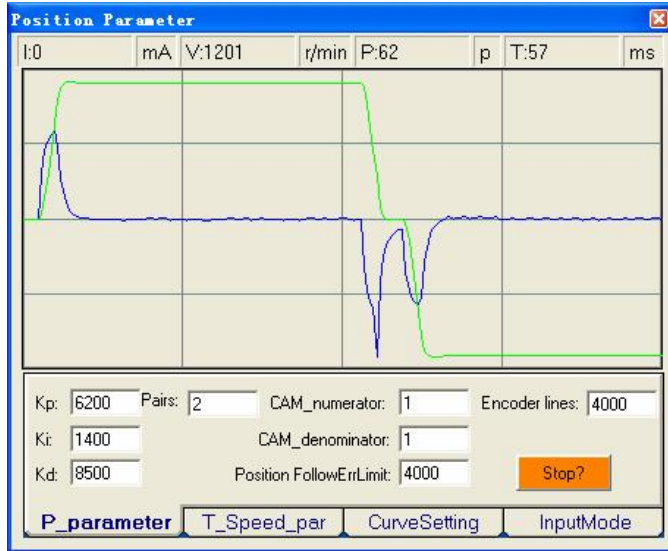

Figure 43: Position following error curve and velocity curve (Kp=6200, Ki=1400 and Kd=8500)

Tuning servo systems formed by ACS606 drives can be summarized as the following rules.

1. If servo system is UNSTABLE, then the first thing of tuning is to stabilize the system. You can increase **Derivative Gain of Position Loop (Kd)** or decrease **Proportional Gain (Kp)** or **Integral Gain** of Position Loop (Ki).
2. If servo system is UNDER DAMPED, then increase Kd or decrease Kp or Ki.
3. If servo system is CRITICALLY DAMPED, then stop tuning and download the parameter settings to the drive's EEPROM.
4. If servo system is OVER DAMPED, then decrease Kd or increase Kp or Ki.

Upload and Download Data

Download Data to EEPROM

A built-in EEPROM in the ACS606 is used to save the configuration data. Every time when you finish configuration or get satisfied parameters after tuning, don't forget to download the data to drive's EEPROM by select **Option->SaveToDrive**. ProTuner will indicate you by a message box as shown in Figure 44 if download is successful. The EEPROM is a nonvolatile storage, so data in EEPROM will not lose when power is off.

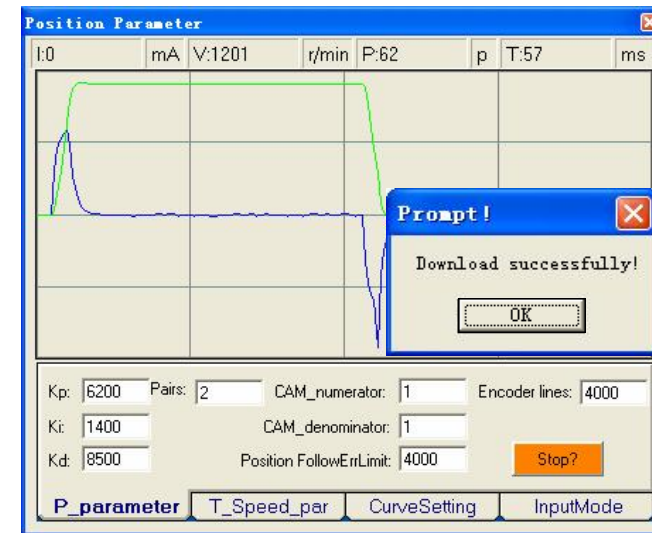

Figure 44: Download to Drive EEPROM

Upload the Data from EEPROM

ProTuner will read the data from the EEPROM automatically when a specific menu is selected. For example, the **Error Check** window will display the last ten errors if click **Err_check** in main menu bar.

Save Data on Harddisk

ProTuner offers a tool to save all the configuration data on harddisk. This tool is very useful when building machines with same motors and other components. Select **Option->Archives**, the upload and download window will appear as figure 45. To save the current data on harddisk, enter a file name in the edit box and then click 'ToDisk' button. See figure 46 for more detail.

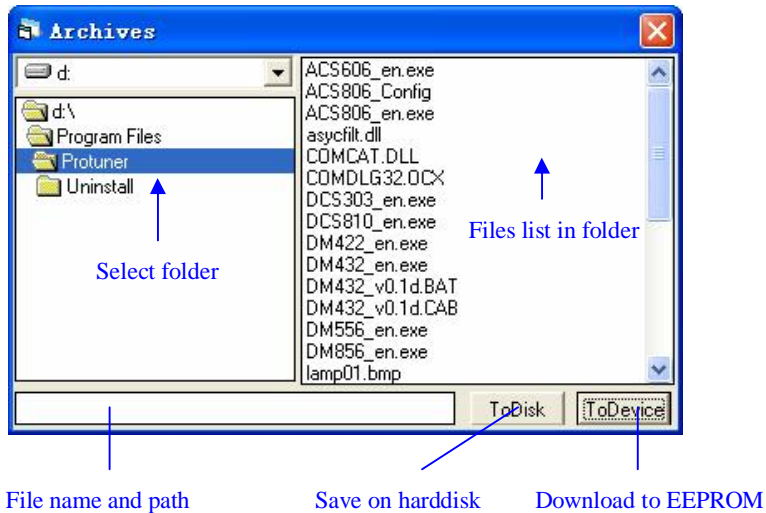

Figure 45: Upload and download window

Download Data to Device

When communication between ProTuner and the ACS606 is established, you can open a configuration file and download the data from the file to the drive. See figure 47 for more details.

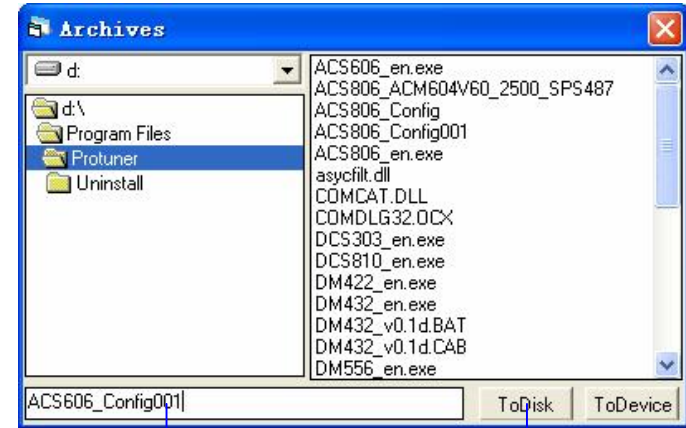

Figure 46: Save data to harddisk

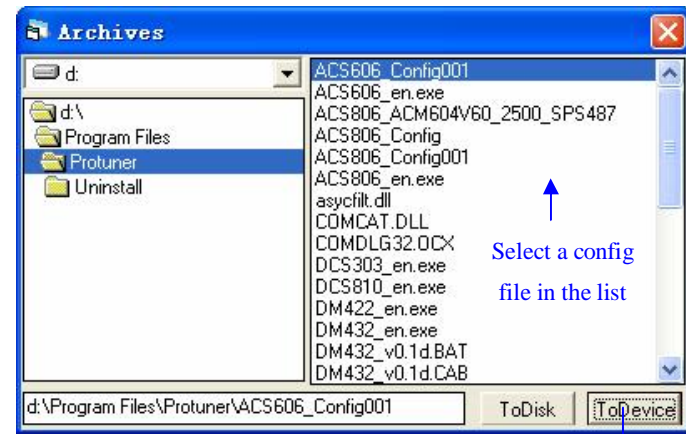

Figure 47: Download data to the drive

Control Signal Input Mode

In **InputMode** tab of **Position Parameter** window, the user can configure control signal input modes.

DirectionDef: Direction Definition. Used to change the default movement direction to a specific input level (High or Low) in the DIR pins. Only active in PUL/DIR mode.

CommandType: Command Type of control signal, including PUL/DIR and CW/CCW. Set this parameter according to **Command Type** of motion controller.

ActiveEdge: Active Edge. The user can set the triggered edge of pulse command signal in this panel. When the drive works in CW/CCW mode, no matter what level is at fixed level terminal, the drive can work properly.

More Information about ProTuner

T_Speed_Par tab

In **Tuning->PositionLoop-> T_Speed_Par** tab, the user can set velocity profile for self motion test and tuning, including Maximum Speed, Acceleration, position move Distance of trapezoidal velocity profile, and Interval, Repeat Times of self motion test.

V_top: Maximum Speed. The maximum speed of trapezoidal velocity profile. Its unit is RPM.

Accel: Acceleration. The acceleration of trapezoidal velocity profile. Its unit is (r/s)/s.

Length: Distance. The distance required to move. Its unit is pulse (count).

Interval: The interval between positive rotation and negative movement.

Repeat_times: The repeat times of positive and negative movement.

CurveSetting tab

In **Tuning->PositionLoop->CurveSetting** tab, the user can choose curves displayed in digital scope of **Position Loop Tuning** window and **DigitalMonitor** window, and set their **Trace Time**. These curves include **Current Following Error** (i_err), **Velocity Following Error** (v_err), **Position Following Error** (p_err), **Current Feedback** (i_bak), **Velocity Feedback** (v_bak), **Position Feedback** (p_bak), **Current Command** (i_ref), **Velocity Command** (v_ref), **Position Command** (p_ref).

i_err: Current Following Error. The difference between commanded current and the actual measured current.

v_err: Velocity Following Error. The difference between commanded velocity and the actual measured velocity.

p_err: Position Following Error. The difference between commanded position and the actual measured position.

i_bak: Current Feedback. This is the actual measured current in motor coil. Ideally, this value should be as close as possible to the commanded current.

v_bak: Velocity Feedback. This is the actual measured velocity measured by the encoder. Ideally, this value should be as close as possible to the commanded velocity.

p_bak: Position Feedback. This is the actual measured position measured by the encoder. Ideally, this value should be as close as possible to the commanded position.

i_ref: Current Command. This is the commanded current.

v_ref: Velocity Command. This is the commanded velocity.

p_ref: Position Command. This is the commanded position.

Trace Time: Trace Time. This is the trace time of the digital scope.

Digital Scope Window

Digital monitor can display curves and dynamic values of different point of different curves. Click **DigitalMonitor** in the main menu will open this window.



Figure 48: Digital scope window

I: Current. Displays dynamic values for Current related curve(s). Dynamic value will change with mouse focus changes. Its unit is mA.

V: Velocity. Displays dynamic values for Velocity related curve(s). Dynamic value will change with mouse focus changes. Its unit is r/min.

P: Position. Displays dynamic values for Position related curve(s). Dynamic value will change with mouse focus changes. Its unit is pulse (count).

T: Time. Displays dynamic values for Time. Dynamic value will change with mouse focus changes. Its unit is ms.

Error Check Window

Click **Err_check** in the main menu will open this window. This window shows both the present status of each error event and their history. Current error event(s) can be reset by clicking **Erase Current Err!** button, and all error events can be reset by clicking **Erase All!** button.

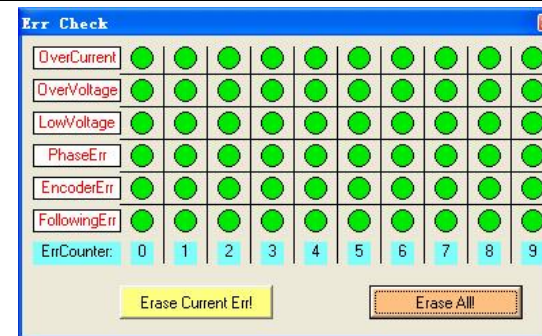

Figure 49: Error check window

OverCurrent: Over-current Protection. Protection will be activated when continuous current exceeds 24A.

OverVoltage: Over-voltage Protection. When power supply voltage exceeds 90 ± 1.5 VDC, protection will be activated.

LowVoltage: Under-voltage Protection. When power supply voltage is lower than 18 ± 1.5 VDC, protection will be activated.

PhaseErr: Phase Error Protection. Motor power lines wrong & not connected and encoder or hall sensors feedback signals wrong connected will activate this protection.

EncoderErr: Encoder Error Protection. No encoder/hall sensor feedback signals or wrong encoder/hall sensor feedback signals will activate this protection.

FollowingErr: Position Following Error Limit Protection. When position following error reaches **Position Following Error Limit** parameter setting in the drive, this protection will be activated.

ErrCounter: Displays current error(s) and current error history.

Erase Current Err!: Erase Current Err button. The user can clear current error(s) by clicking this button.

Erase All!: Erase All! button. The user can clear all error(s) including error history by clicking this button.

7. Using Tips

Change PPR by Electronic Gear

PPR(pulses per revolution) is the counts/pulses to make motor move one turn. If the default PPR can not satisfy your application, a way to change it is setting electronic gear in ProTuner as shown in figure 50. You can set this parameter in the position tuning window by select **Tuning->PositionLoop->P_parameter**. For ACS606, the actual PPR can be calculated by the following formula:

$$PPR = \frac{4 \times Encoder_resolution \times CAM_denominator}{CAM_numerator}$$

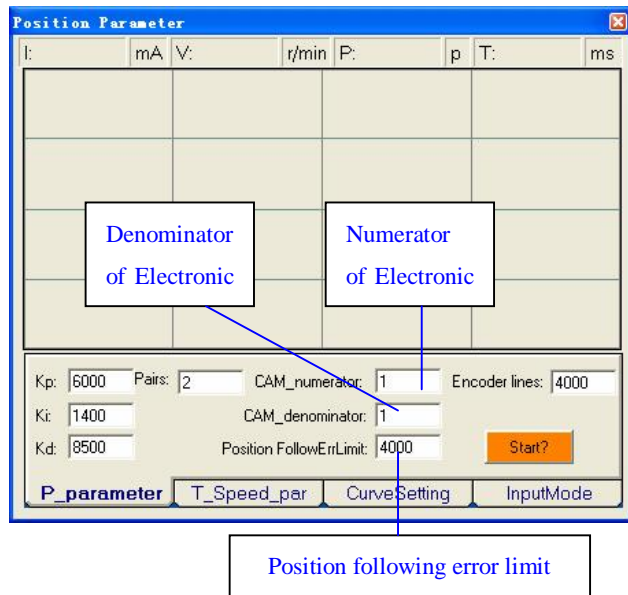

Figure 50: Electronic gear and position following error setting

Position following Error Limit

The ACS606 will activate a position following error if position error between command and encoder feedback exceeds the setting limit value. To set the limit value, please select **Tuning->PositionLoop->P_parameter** and find the **Position FollowingErrLimit** edit box. See figure 50.

Sequence Chart of Control Signals

In order to avoid some fault operations and deviations, PUL, DIR and EN should abide by some rules, shown as the following figure:

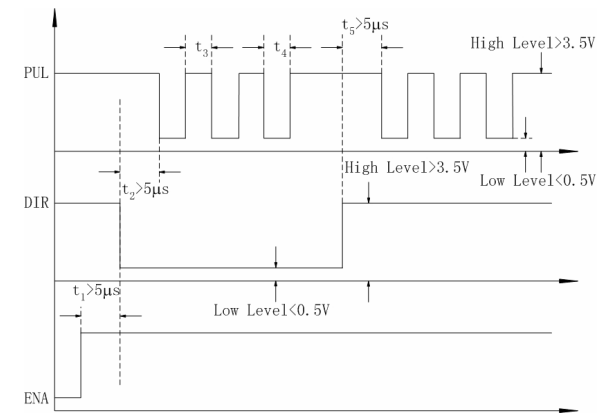

Figure51: Sequence chart of control signals

Notes:

- t_1 : EN must be ahead of DIR by at least 5 μ s. Usually, ENA is NC (not connected). See **Connections** section for more information.
- t_2 : DIR must be ahead of PUL active edge by at least 5 μ s to ensure correct direction.
- t_3 : Pulse width not less than 0.85 μ s;
- t_4 : Low level width not less than 0.85 μ s.

Protection Functions

To improve reliability, the drive incorporates some built-in protection functions. The ACS606 uses one RED LED to indicate what protection has been activated. The periodic time of RED is 5 s (seconds), and how many times the RED turns on indicates what protection has been activated. Because only one protection can be displayed by RED LED, so the drive will decide what error to display according to their priorities. See the following **Protection Indications** table for displaying priorities.

Over-current Protection

Protection will be activated when continuous current exceeds 20A, and RED LED will turn on once within each periodic time (5 s).

Over-voltage Protection

When power supply voltage exceeds 63 ± 1.5 VDC, protection will be activated and RED LED will turn on twice within each periodic time (5 s).

Phase Error Protection

Motor power lines wrong & not connected and encoder or hall sensor feedback signals wrong connected will activate this protection. RED LED will turn on four times within each periodic time (5 s).

Encoder or Hall Error Protection

No encoder feedback signals or wrong encoder/hall sensor feedback signals will activate this protection. RED LED will turn on five times within each periodic time (5 s).





Position Following Error Protection

When position following error reaches Position Following Error Limit parameter

setting in the drive, this protection will be activated. RED LED will turn on seven times within each periodic time (5 s). Note that wrong motor connection will cause this protection too. Please check your motor connection if this protection is activated at the startup.

Attention: Since there is no protection against power leads (+, -) reversal, it is critical to make sure that power supply leads correctly connected to drive. Otherwise, the drive will be damaged instantly.

Protection Indications

Priority	Time(s) of ON	Sequence wave of RED LED	Description
1 st	1		Over-current protection
2 nd	2		Over-voltage protection
3 th	4		Phase error protection
4 th	5		Encoder or Hall error protection
5 th	7		Position following error protection

Maximum Pulse Input Frequency

Maximum Pulse Input Frequency is the highest frequency at which the drive can interpret encoder feedback. To convert this frequency to RPM, use the following formula:

$$RPM_{(max)} = \frac{(Max \ Pulse \ Input \ Frequency) \times 60}{Pulse \ per \ resolution}$$

8. Accessories

ACS606 Accessories and Connections

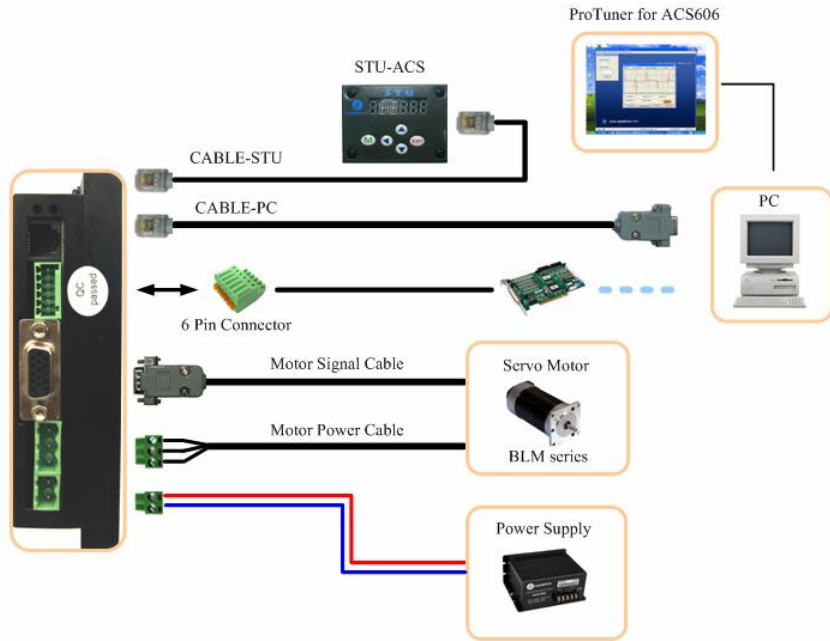

Figure 52: ACS806 accessories and connections

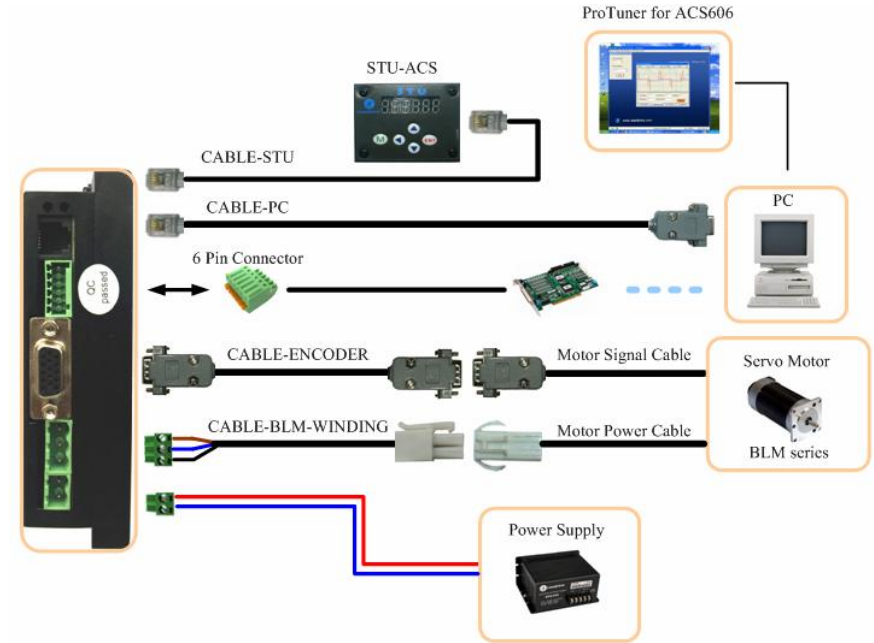

Figure 53: ACS606 accessories and connections with extended cable

More Information about ACS606 Accessories

ProTuner	
Description	PC-based configuration & tuning software.
Order	Standard Accessory, user can download from Leadshine website for free.

CABLE-PC

Description	Special RS232 cable designed to setup communication between the drive and PC-based configuration & tuning software ProTuner .
Order	Standard Accessory, one is enough for a user to configure and tune multiple drives.

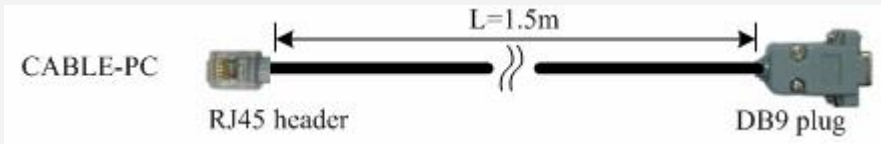

STU-ACS

Description	Handheld configuration & tuning unit.
Order	Optional Accessory, one is enough to configure and tune multiple drives.



CABLE-STU

Description	Special RS232 cable designed to setup communication between drive and Handheld configuration & tuning unit STU-ACS .
Order	One STU-ACS needs at least one.

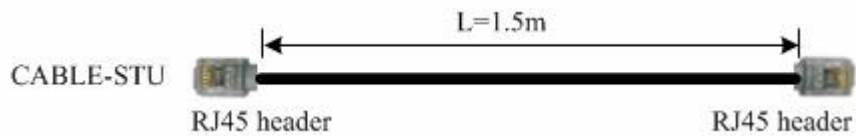

6 pin Control signal Connector

Description	Self-locked connector for control signals include PUL+, PUL-, DIR+ and DIR-, ENA+, ENA-.
Order	Standard Accessory, shipped with the drive for free.

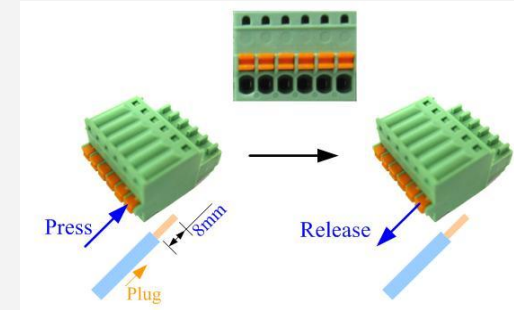

CABLE-BLM-WINDING

Description	Extended cable for power leads between the drive and Leadshine BLM series DC brushless servo motor.
Order	Optional Accessory, Leadshine provides 1.2m, 2.2m, 5m, 10m cable for user selection. Users can select the proper length according to their needs.

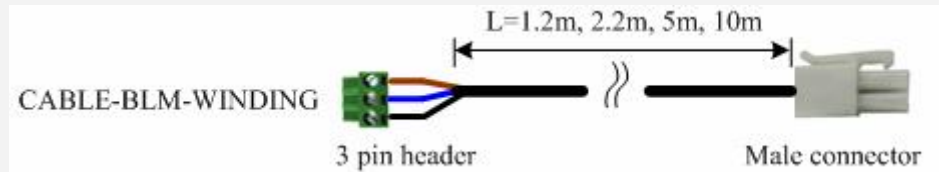

	Pin	Color	Signal	Description
Wires	1	Red	U	Motor phase U
	2	Blue	V	Motor phase V
	3	Black	W	Motor phase W

CABLE-ENCODER

Description	Extended cable for the feedback wires between the drive and servo motor.
Order	Optional Accessory, Leadshine provides 1.2m, 2.2m, 5m, 10m cable for user selection. Users can select the proper length according to their needs.

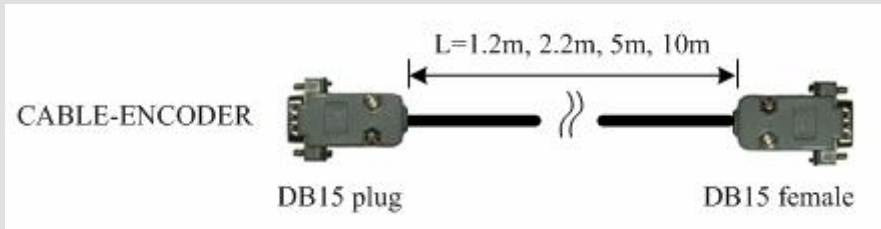

APPENDIX

TWELVE MONTH LIMITED WARRANTY

Leadshine Technology Co., Ltd. warrants its products against defects in materials and workmanship for a period of 12 months from shipping date. During the warranty period, Leadshine will either, at its option, repair or replace products which proved to be defective.

EXCLUSIONS

The above warranty shall not apply to defects resulting from: improper or inadequate handling by customer; improper or inadequate customer wiring; unauthorized modification or misuse; or operation beyond the electrical specifications of the product and/or operation beyond environmental specifications for the product.

OBTAINING WARRANTY SERVICE

To obtain warranty service, a returned material authorization number (RMA) must be obtained from customer service at e-mail: tech@leadshine.com before returning product for service. Customer shall prepay shipping charges for products returned to Leadshine for warranty service, and Leadshine shall pay for return of products to customer.

WARRANTY LIMITATIONS

Leadshine makes no other warranty, either expressed or implied, with respect to the product. Leadshine specifically disclaims the implied warranties of merchantability and fitness for a particular purpose. Some jurisdictions do not allow limitations on how long and implied warranty lasts, so the above limitation or exclusion may not apply to you. However, any implied warranty of merchantability or fitness is limited

to the 12-month duration of this written warranty.

SHIPPING FAILED PRODUCT

If your product should fail during the warranty period, e-mail customer service at tech@leadshine.com to obtain a returned material authorization number (RMA) before returning product for service. Please include a written description of the problem along with contact name and address. Send failed product to distributor in your area or: Leadshine Technology Co., Ltd. Floor 3, Block 2, Tianan Industrial Park, Nanshan Dist, Shenzhen, China. Also enclose information regarding the circumstances prior to product failure.

Contact Us

China Headquarters

Address: 3/F, Block 2, Nanyou Tianan Industrial Park, Nanshan District Shenzhen, China

Web: <http://www.leadshine.com>

Sales Hot Line:

Tel: 86-755-2643 4369 (for All)

86-755-2641-7674 (for Asia, Australia, Africa areas)

86-755-2640-9254 (for Europe, America areas)

Fax: 86-755-2640-2718

Email: sales@leadshine.com.

Technical Support:

Tel: 86 755-2641-8447 and 86-755-2647-1129

Fax: 86-755-2640-2718

Email: tech@leadshine.com and vic@leadshine.com.

Leadshine U.S.A

Address: 25 Mauchly, Suite 318 Irvine, California 92618

Tel: 1-949-608-7270

Fax: 1-949-608-7298

Web: <http://www.leadshineUSA.com>

Email: sales@leadshineUSA.com and support@leadshineUSA.com.

Leadshine Hong Kong

Address: Rm 3, 9/F, Block E, Wah Lok Industrial Center, 31-41 Shan Mei St., Fo Tan, Shatin, Hong Kong

Tel: 852-2952-9114

Fax: 852-2952-9395

Email: hk_sales@leadshine.com.